

# 65" HOWE RESIN FREESTANDING TUB

Cat. No.  
RTOVN64-OF



L: 65-1/8"  
W: 33-1/2"  
H: 24-1/2"

Water depth: 17-3/8" to top of top  
Water depth: 14-3/8" to overflow

**The following is recommended for RTOVN64-OF soaking tubs:**

- Faucets: part #7082 or 7088
- Freestanding Bath Supplies: #4502
- Freestanding Filler: #7901, 7922, or 7952

**(Do Not Need Bath Supplies)**

Gallon Capacity : 88  
Shipping Weight: 429 lbs.  
Empty Weight: 329 lbs.  
Filled Weight: 1,064 lbs.

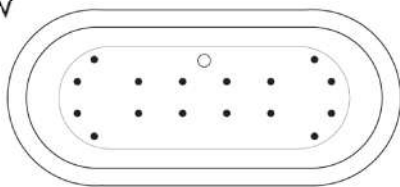

(Air jet configuration if system is added, more info on page 2.)

## Features:

- ▶ Poly-resin blend is the same color throughout
- ▶ Available in Matte or Gloss finish
- ▶ 1" Rim
- ▶ No faucet holes
- ▶ Built-in overflow slot
- ▶ Includes white pop-up drain
- ▶ Tub is thoroughly inspected before shipment
- ▶ Includes built-in adjusters
- ▶ IAPMO Certified
- ▶ New: Air jet system now available, more info on page 2

## Tub Colors:

WH Matte White  
WHGL Gloss White

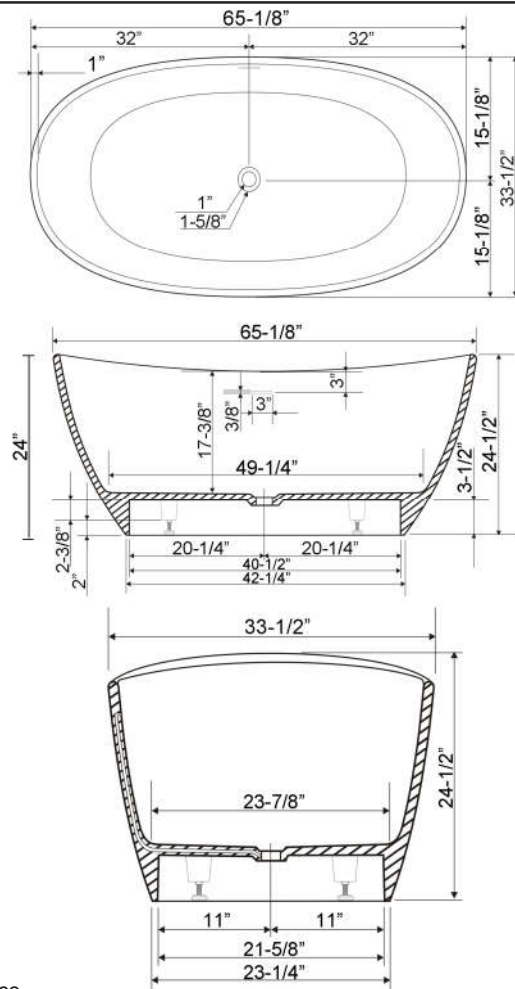

Dimensions of fixture are nominal and specifications subject to change without notice.

# BATHTUB AIR JET KIT

Cat. No.  
AIR KIT 1, AIR KIT 2



- A** AIR JET - Bottom air jets for maximum bubble action.
- B** BLOWER - The heart of the massage system.
- C** MANIFOLD - Double back flow security prevention device.
- D** FLEXIBLE PVC HOISING - IAPMO certified.
- E** MAIN AIR INTAKE HOSE - High temperature and pressure resistant.

## Features:

- ▶ 750 Watt blower motor operates system
- ▶ 300 Watt air heater warms air
- ▶ System powered by 120V
- ▶ 16 brass air jets placed in bottom of tub
- ▶ Each air jet has 24 holes
- ▶ Air jet caps available in white (AIR KIT 1) or black (AIR KIT 2)
- ▶ Includes 1 1/4" x 3' main air hose plus 1 1/4" x 9' extension hose
- ▶ Automatic system purge after each use
- ▶ Automatic safety timer turns off system after 20 minutes
- ▶ Includes water tight remote control
- ▶ Compatible with most acrylic, copper and resin tubs with no feet
- ▶ Not available with cast iron tubs or tubs with feet

**Air Kit is installed in tub before shipment**

## INSIDE TUB VIEW - WILL VARY BY TUB DESIGN



Air Jet



Remote

**Oval bathtub**  
Sample jet configuration

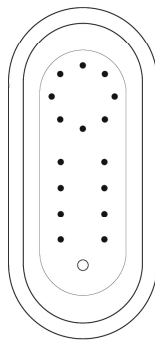

with end drain

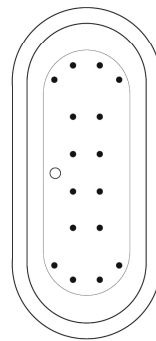

with center drain

**Rectangular bathtub**  
Sample jet configuration

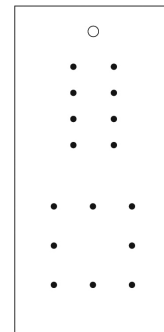

with end drain

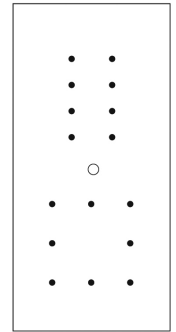

with center drain

**Round bathtub**  
Sample jet configuration

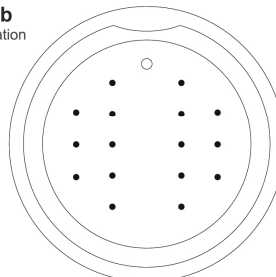

These diagrams are general representations.  
Jet placement may vary dependent on tub shape

### Features:

(16) Maxi Air Jets



Elbows for air jets



Tees for air jets